

Autostream[®]

SINCE 1976

Self Feathering Sailboat Propellers

'S2' Series Stainless Steel Saildrive Propellers



INSTALLATION AND OPERATING INSTRUCTIONS

Index

Index	1
Foreword	1
Getting to Know Your Propeller Parts	2
Pre-installation check	3
Fitting your AUTOSTREAM propeller	4
Anti fouling your propeller	7
Operating instructions	7
Sea Trials & Pitch Adjustment	8
Shaft Generators and Electric Motor Regeneration	9
Recommended Greases	9
Removal of Propeller	9
Servicing	10
Replacing the Zinc Anode	10
Replacing the Blade Bearings and/or O-ring Seals	10
Contact Details & Notes	12

Foreword

At first glance it may appear that installation is complex, this is not the case. These instructions are very detailed to assist a person without any trade skills to successfully fit & adjust our propellers.



Please read and follow these instructions carefully, Failure to do so may result in unsatisfactory performance, vibration, additional slipping/haul out costs, loss of propeller or voiding your 5 year warranty.

Our experience has shown most problems stem from not following these instructions. Avoid potential frustration and read on...

Getting to Know Your Propeller Parts

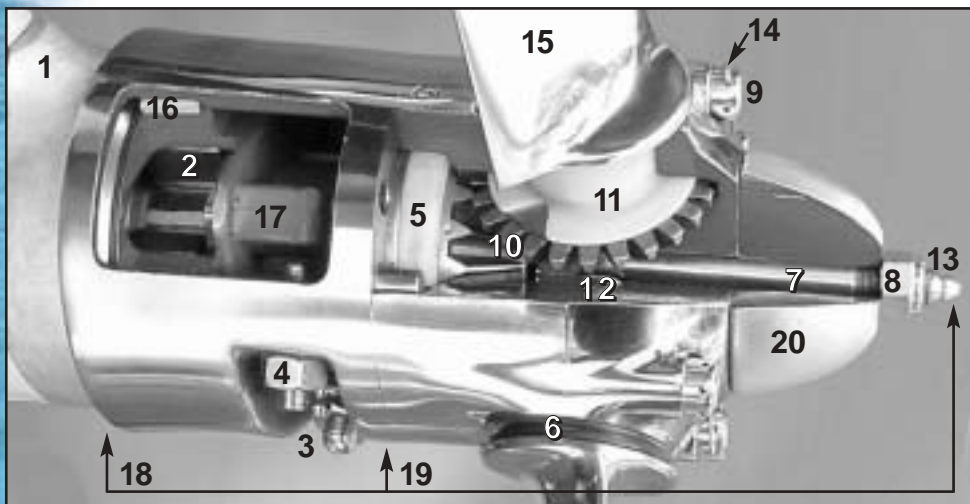

- | | |
|----------------------------|----------------------------------|
| 1. Saildrive Zinc Anode | 11. Delrin Blade Bearing |
| 2. Rubber cushion | 12. Bronze Blade bush |
| 3. Pitch adjusting screws | 13. Grease nipple (Zerk fitting) |
| 4. Pitch adjuster lock nut | 14. Locking wire |
| 5. Delrin thrust bearing | 15. Blade |
| 6. Blade O-ring | 16. Delrin Drive Gear Bearing |
| 7. Grease tube | 17. Stop lug |
| 8. Nyloc nut | 18. Drive assembly |
| 9. Cap Head Screw | 19. Blade assembly |
| 10. Drive gear | 20. Zinc Anode |

Contents of the kit shipped with your propeller.



1. Grease cartridge (Type supplied varies)
2. 17mm Wrench
3. Spare Hub O-ring
4. Spare Blade O-rings (3)
5. 5mm Hex key
6. 6mm Hex key
7. Spare zinc anode
8. Split washer
9. Propeller Shaft nut
10. Locking screw
11. Large flat washer
12. Locking wire (2)
13. Grease Nipple (Zerk Fitting)
14. Brass plug (for setting alignment)





Before proceeding please read the conditions of the 5-year warranty and remember to send in your warranty registration. If no registration is received the warranty will apply from the date that the propeller was shipped from the factory. You can register your warranty on-line, or send in via post or fax, you will find all the details at the rear of this booklet.

NOTE: This may be a convenient time to replace the Sail Drive Leg zinc anode. This is to protect the saildrive leg and is not replaced by the propeller anode, which only protects the propeller.



Pre-installation check

The points below must be the same after installation

-  Before disassembling the propeller note the leading and trailing edges of the blades when they are in the feathered position, that is when the blades align fore and aft along the centre line of the boat. The leading edge is the straighter edge, while the trailing edge is more curved, the leading edge is identified with a label when the propeller was originally shipped from the factory.
-  Note how the blades feel when rotated by hand. The blade resistance to turning should feel the same after the propeller is fitted, but **before** being filled with grease.

Tools and parts required for installation:

6mm Hex Key	supplied with the propeller
Grease cartridge	supplied with the propeller
Large Flat Washer	supplied with the propeller
Propeller nut	supplied with the propeller
Split washer for propeller nut	supplied with the propeller
Propeller nut lock screw	supplied with the propeller
Locking wire	2 length supplied (1 spare)
Pliers for lock wire	not supplied
Grease gun	not supplied
20mm (13/16") socket and wrench	not supplied
(The above socket is the same size as a standard spark plug socket)	
11mm (7/16") socket and wrench	not supplied
Soft-faced hammer or small block of wood	not supplied

Tools required for Pitch Adjustment:

5mm Hex key	supplied with the propeller
17mm (11/16") wrench	supplied with the propeller

Required to remove / refit zinc anode:

14mm (9/16") wrench	not supplied
---------------------	--------------

Spares supplied with the propeller:

1 x Spare Zinc Anode 4 Spare 'O' Ring Seals 1 Spare Lock Wire

Fitting your AUTOSTREAM propeller

1. Remove the old propeller and clean up the shaft. Replace the zinc anode on the saildrive leg if necessary. Any line cutter or spacers should be left in place.

 **NOTE:** For fitting and removal of the propeller, the **Propeller Body** is separated into two halves as pictured in **FIG 1**. The **Blade Assembly**, which supports the blades and the **Drive Assembly**, which houses the drive gear, cushion hub and shaft nut. **DO NOT** remove the Nyloc nut that secures the cone shaped zinc anode to the blade assembly, as this is all that holds the blades and mechanism together when the cap head screws are removed.

2. Remove the 6 cap head screws using the 6mm hex key supplied.

3. Rotate the propeller blades to the feathered position and as shown in **FIG 2**, support the blade assembly on your wrist while grasping the drive assembly (front) of the propeller body. Using a soft-face hammer or small block of wood, gently tap the edge of the blades to separate the propeller blade assembly from the drive assembly taking care not to drop either section.

4. Fit any original spacers or washers and line cutters to the shaft, followed by the large flat washer supplied with the propeller. See **Fig 3**.

5. Ensure the rubber cushion is properly fitted to the propeller. This is the square rubber ring visible inside the forward end of the propeller.

6. Push the drive assembly firmly on to the shaft and rotate it while checking that it is not touching the leg anode. The clearance will vary as suppliers of leg anodes vary. If the propeller body is touching, check that the correct spacers and washers are in place. If there is still insufficient clearance, shape the anode with a file to suit. **DO NOT** remove any washers or spacers to decrease this clearance.

7. Remove the drive assembly from the shaft.

8. Lightly grease the splines of the shaft.

9. Stand the drive assembly on end, with the drive gear upwards, Drop the two halves of the split washer into the end of the gear and move into place with your finger as pictured in **Fig 4**.

FIG 1



FIG 2



FIG 3



FIG 4

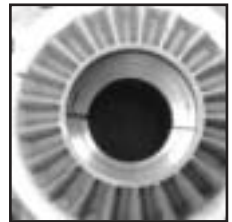

WARNING

It is crucial that the two split washers are fitted correctly - If left out, most of your propeller will fall off the first time it is used in reverse.



10. Drop the round end of the nut into the end of the gear so that the step fits inside the two halves of the split washer.
11. Hold the nut in position with your finger and slowly slide the drive assembly onto the shaft until you feel the shaft thread just contact the nut.
12. Lightly tighten the nut with your fingers.
13. Fit the cap head locking screw into the end of the shaft, through the centre of the nut and screw in flush, **but do not tighten yet**.
14. Tighten the main propeller nut to 50Nm (36ft/lbs) torque.

USE CAUTION



Most Yanmar shafts are heat-treated. The threaded section can snap off completely if the nut is tightened excessively.

15. Tighten the cap head locking screw to 15nm (11ft/lbs) torque.
16. Check to see if one of the pairs of holes in the cap head locking screw aligns with any one pair of slots in the nut. This is to allow you to insert a piece of the locking wire through the slots and cap head screw as pictured in Fig 5.
17. If you cannot insert the locking wire, tighten the locking screw slightly more until you can.
18. Twist the ends together to secure, see Fig 6. The wire must not protrude past the end of the gear, as it will catch on the blade assembly and interfere with the operation of your propeller.

For your information: The thread of the locking screw is finer than the thread of the shaft nut, if the nut should come loose it will wind up tight against the locking screw and can not come undone until the wire is removed.

19. Carefully align the small dot on the outer edge of the gear with the relevant dot for left or right. 'R' is for RH rotation (clockwise when viewed from astern), 'L' is for Left Hand rotation (counter clockwise).

Fig 7 shows a RH setup.

20. Using the 5mm hex key supplied, gently tighten the recessed brass plug, located between the pitch adjusting screws, just enough to stop the drive body from rotating, this will prevent the gear rotating out of alignment while fitting the blade assembly. Do not over tighten. (**Fig 8**)

21. Prepare the six cap head screws by ensuring they are clean and applying a little grease to the threads and underside of the cap heads.
- Note:** New propellers are supplied with a brown anti-seize compound already on the threads for your convenience. This should be left in place.

FIG 5

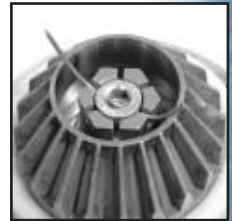

FIG 6



FIG 7

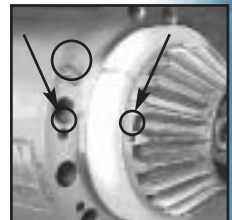
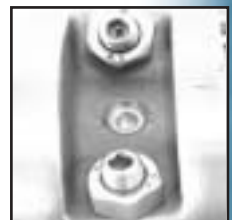

FIG 8



22. While ensuring that the leading edge of the blades are facing ahead as per **Fig 1**, turn all three blades to the feathered position as per **Fig 9**.

23. Align the number "1" stamped on the drive assembly with the number "1" on the blade assembly as per **Fig 10**. Fit the blade assembly into place and fit 6 cap head screws, tightening only lightly at this stage.

24. Undo the brass plug 3-4 turns and perform the following checks.

IMPORTANT CHECKS:



Rotate the propeller so that the blades turn 90 degrees from the feathered position and check that the edges of **ALL THREE** blades align with the split in the body of the propeller, as shown in **Fig 11**.



Check that the blades rotate freely from the forward stop to the reverse stop as per the pre-installation check. If movement is not free then the propeller must be dismantled and checked for the reason. The most likely cause is the index numbers on the two propeller assemblies are not lined up as per step 23 and **Fig 10**.

TIP: If one or more of the blades are not aligned, remove all of the cap head screws and refit only two screws, diagonally opposite each other, screwing in only one turn. This will allow you to pull the blade assembly away from the drive gear and move the blade(s) that are not in the correct position (you may need to wobble the blade assembly slightly if the blade does not turn).



Any problems must be rectified NOW. Poor performance, serious vibration or an inability of the propeller to feather will result if the above points are not correct.

25. When all is correct, tighten the 6 cap head screws to 20Nm (15ft/lbs) torque and fit the lock wires as per **Fig 12**.

26. **Remove the brass plug and retain for future use.** Fit the supplied grease nipple into the hole where the brass plug was originally fitted between the pitch adjusting screws, using an 11mm (7/16") socket. **DO NOT OVER TIGHTEN.**

27. Rotate the propeller from stop to stop and compare to confirm it rotates as it did during the pre-installation check.

28. Grease the propeller with the grease supplied or an equivalent, through both grease nipples until grease appears at the blade journals or the forward end of the propeller. **Work the propeller back and forth, between forward and reverse a number of times to disperse within the propeller.** Recommended greases are listed later in this book should replacement grease be required.



NOTE: It is important that the propeller should be well filled with grease. This will prevent marine growth inside the propeller and the formation of stagnant water that can promote corrosion.

29. **Your installation is now complete.**

FIG 9

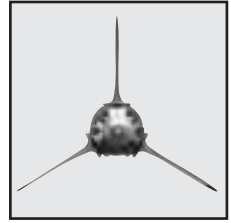

FIG 10

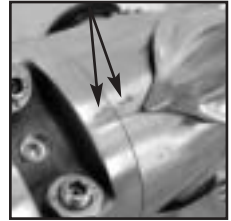

FIG 11

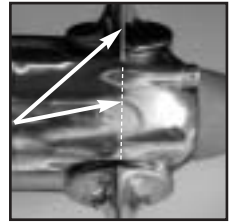
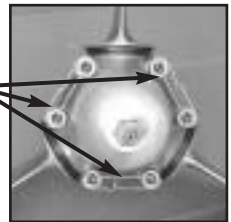

FIG 12



Anti fouling your propeller

Modern self-abating anti fouls will not last very long if the boat is used under power for extended periods of time.

We suggest if the boat is moored for long periods, especially in high fouling areas, that the propeller be anti fouled.

If the boat is mainly used in clean ocean water, anti-fouling is usually not required.

If anti-foul is used on the propeller:

- Rough the surface of the blades slightly with abrasive paper and apply a suitable primer followed by several coats of a good quality hard antifoul paint.
- **NOTE:** When applying the paint do not allow a heavy uneven build up of paint to occur at the leading and trailing edges of the propeller blades. Try to keep the total paint thickness reasonably uniform over the blade surface. A heavy build up of paint on the trailing on one side of a blade can cause an uneven water flow over the blade and the blade may not feather true fore and aft which could cause the propeller to rotate under sail if the gearbox was left in neutral.
- **Do not** paint the tail cone anode or grease nipples.
- **Do not** allow paint to run into the blade journals and restrict the ease of blade movement.

Operating instructions

Operation under engine power:

Operate your sailboat under power as though it has a fixed blade propeller.

The propeller blades will orientate automatically when the engine is engaged in either forward or reverse.

The propeller will go into reverse at high speed if required for emergency stopping. It will not damage the propeller but continued high-speed direction changes will accelerate the wear on both the propeller and your drive train.

CAUTION: Autostream propellers are much more efficient in reverse than other types of propellers, take care reversing in confined areas as you may be doing 3 to 4 times the speed for the same rpm that you were with your old propeller.

Feathering the propeller:

To feather the propeller, drive ahead at a speed slightly greater than the speed the boat is currently sailing at, this will ensure the propeller is in the ahead position, or it will not feather.

Switch off the engine whilst still engaged in forward gear.

After the engine has stopped, momentarily engage reverse gear - this will prevent the propeller shaft rotating and the propeller will feather.

To check if the propeller is feathered, put the gear lever in neutral, the propeller shaft should not rotate.

If it does then the propeller is not feathered and the procedure should be repeated.

Once feathered the gear lever can be left in any position and the propeller will not come out of the feathered position until the propeller shaft is rotated by the engine.

This procedure is affective for both hydraulic and mechanical transmissions.

NOTE: When first filled with grease the movement of the propeller blades will be a little stiff until the grease is dispersed inside the propeller body. Until this happens the time it takes for the propeller to feather may be a little longer.

Going from forward to reverse at idle about 10 times will help disperse the grease quicker.

NOTE: The propeller will only feather from the ahead position.

Note for high speed use: Autostream propellers have been regularly tested at sailing speeds in excess of 25 knots and have been proven to stay feathered under normal conditions. It is highly recommended when sailing at high speeds that the gearbox be left in neutral. This will prevent potential engine damage should the propeller be forced out of the feathered position by a foreign object in the water.

Sea Trials & Pitch Adjustment

The propeller pitch is generally preset using the information supplied when your propeller was ordered. However, fine-tuning will achieve optimum performance.

The pitch is correct when the engine just reaches the engine manufacturers maximum continuous rated rpm, under flat-water conditions.

Over revving is not enough pitch, while black smoke or '*lugging*' is too much pitch.

Half a turn of the pitch adjusting screw will make about 150 rpm alteration on most installations.

Reverse rarely needs adjustment and is set at a finer pitch than forward to assist with control and minimise sideways "prop walk"

To adjust the pitch, slightly loosen the lock nut of the screw you wish to adjust using the supplied 17mm wrench. Turn the screw in the required direction using the supplied 5mm hex key and retighten the locking nut (Refer to Fig's 13 and 14). **Use caution not to over tighten the locking nuts.**

NOTE: The propeller can be in any position while adjusting the pitch.

There are 'R' and 'F' marks by the pitch adjusting screws to indicate the forward and reverse pitch adjusters for the initial factory set up. If the prop rotation has been reversed at any time these will be reversed also. The "Rule of thumb": and pictures below will always be correct.

RULE OF THUMB

When the propeller is covered in anti-foul or while underwater the adjuster markings are impossible to see, the following rules always apply.

With the pitch adjusting screws **on the same side of the propeller as the direction of rotation**, when looking ahead, (left side for left hand or counter clockwise rotation and right side for right hand or clockwise rotation).

The **UPPER** adjuster is for **FORWARD** screw **IN** to **INCREASE** pitch.

The **LOWER** adjuster is for **REVERSE** screw **OUT** to **INCREASE** pitch

Left Hand Rotation

AHEAD Adjustment
Screw in to INCREASE pitch

ASTERN Adjustment
Screw in to DECREASE pitch

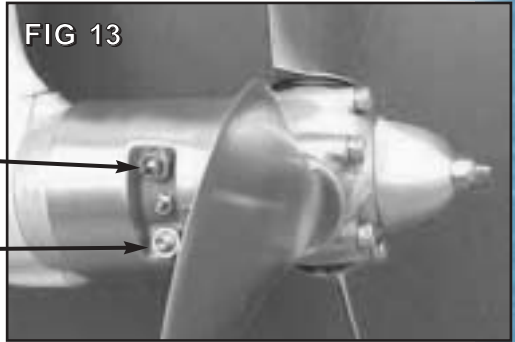

Right Hand Rotation

AHEAD Adjustment
Screw in to INCREASE pitch

ASTERN Adjustment
Screw in to DECREASE pitch

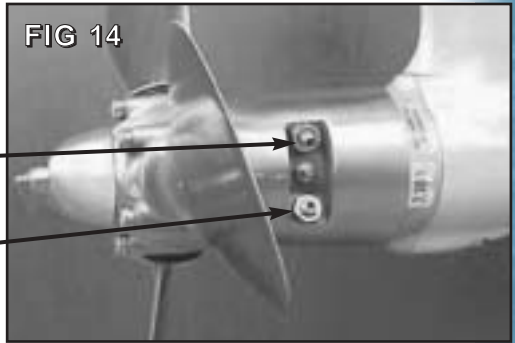

Shaft Generators and Electric Motor Regeneration:

As the propeller will not feather from the reverse position, this feature can be utilized to provide drive for power generation.

To engage the propeller, start the engine and briefly reverse as you begin to sail off, then select neutral and shut down the engine. The propeller blades will now stay in the reverse position and provide rotation. To feather the propeller when required simply follow the normal procedure for feathering as described previously.

Recommended Greases

Any light multi-purpose, lithium based grease, particularly if labelled as suitable for marine use, is suitable for use in your AUTOSTREAM Propeller. Extreme pressure grease can be used but is not required.

A few alternatives are...

Valvoline Val Plex M grease, **Mobil** Mobilgrease XHP, **Castrol** LMX, **Spheerol** AP or LMM, **Total** Lubmarine EPEXZ.

 NOTE: It is important that the propeller is well filled with grease. This prevents marine growth inside the propeller and stagnant water forming that can promote corrosion.

Removal of Propeller

The removal of your propeller is a straightforward reversal of the installation procedure.

Servicing

If installed correctly your AUTOSTREAM propeller will give you years of trouble free service.

The service requirements are minimal and all that is required is...

Periodic cleaning of the propeller and inspection of...

All nuts and screws for tightness.

The blades and propeller body for damage.

Blade O-rings for damage from fishing line etc. Refer to the following section to replace the O-rings.

The Zinc Anode, this should be replaced when down to 25% of its original size.

Check the blades for excessive play and renew the bearings if necessary. See the following section to replace the bearings.

Note: A little play is normal, it takes many years of regular use for the bearings to start showing signs of wear.

Grease the propeller once a year, this can be done under water via the grease nipples fitted in the nose and between the pitch adjusting screws of the propeller. Fill with grease until it can be seen appearing around the blade seals.

Note: Work the propeller back and forth, from forward to reverse to distribute the grease. The propeller may take a little longer to feather until the grease has distributed.

Replacing the Zinc Anode

The zinc anode should be replaced when eroded down to approximately 25% of its original size.

In normal use the zinc anode should last between 6 & 18 months. If your zinc anode is lasting less than six months have your boat checked for an electrical leakage problem.

Undo the 14mm (9/16") Nyloc nut at the grease nipple and slide the anode off.

Clean the area where the zinc anode is mounted with abrasive paper.

Fit the new zinc anode and tighten the Nyloc nut.

NOTE: We recommend that you still use a zinc anode on the saildrive leg to protect the saildrive unit, the propeller zinc anode will only protect the propeller.

Replacing the blade bearings and/or O-ring seals.

DO NOT INTERCHANGE PARTS between propellers. Many of the components are machined as matched sets, mixing them up may interfere with the smooth operation of your propeller.

1. Rotate the blades to the feathered position and remove the six 6mm cap head screws.
2. Tap the leading edge of the blades with a soft-faced hammer or small block of wood to separate the blade assembly from the drive assembly.
3. With a wire hook or similar pull the 'O' ring seals out of their grooves and roll them over the flange at the base of the blade so they are not sitting in-between the blade and where it joins the propeller body. **FIG 15**

FIG 15



4. Remove the zinc anode (tail cone) by undoing the 14mm (9/16") nut and then partly replace the nut to protect the grease nipple.
5. Support the blades and using a soft-faced hammer or small block of wood to gently tap the nut to separate the two blade assembly halves. Remove the nut and disassemble the blade assembly.
6. Remove the bronze bearings from the blade spigots by carefully filing through them until they split.
7. Clean up the blade spigots where the bronze bushes go with fine abrasive paper.
8. Identify the end of the new bush that has a small internal step. This end of the bush should be placed furthest from the gear on the blade.
9. Fit the new bearings using a little Loctite grade 603. Wipe off any excess Loctite and leave to cure.
10. Remove the old Delrin (plastic) bearings.
11. Clean up all bearing and seal surfaces, paying particular attention to the areas where the O-ring seals are positioned.
12. Lightly grease and fit the new blade bearings with the flange of the bearing placed up against the blade gear face.
13. Fit new 'O' ring seals over the blade gears and roll them up and over the flange of the blade.
14. Reassemble the blade assembly. **Ensure that the numbers stamped on the blades match the corresponding numbers on both sections of the blade assembly hub.**
15. Fit the zinc anode and nut, tighten the nut using care not to over tighten.
16. After assembling the blade assembly, rotate the blades to either the forward or reverse position and push the blade O-ring seals back over the blade flange into their correct positions.
17. Pull out and examine the rubber cushion hub, replace if damaged or worn.
18. Refit the blade assembly as per "Fitting your AUTOSTREAM Propeller".

Notes and Important Data

Propeller serial number Nut size & thread

Shaft Size & Taper Purchase Date

Purchased from

Notes:

.....

.....

.....

.....

.....

.....

.....

.....

.....

.....

Contact Details

The team at SEAHAWK would like to thank you for purchasing your AUTOSTREAM propeller and wish you many years of happy and trouble free sailing.

If we can help you in anyway, if you would like some clarification on these instructions or if you would like some advice, please do not hesitate to contact us. We also invite you to comment on your experiences with your AUTOSTREAM propeller once you have spent some time using it.

Seahawk Pty Ltd
41 London Drive,
Bayswater, Vic, 3153
AUSTRALIA

www.seahawk.com.au
info@seahawk.com.au
Phone +61 (3) 9761 1633
Fax +61 (3) 9761 0727